

AV-Drop STANDARD COMPONENTS

"A" 5'h SET

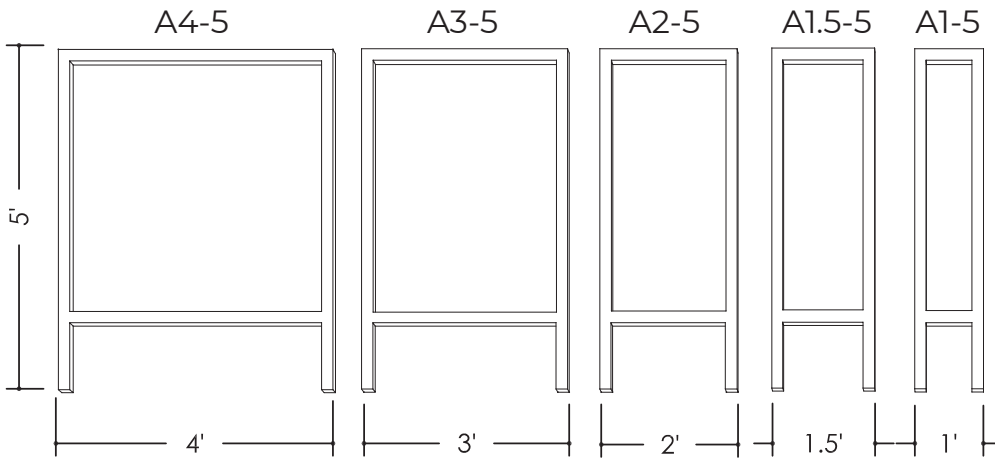

"F1-5" SET

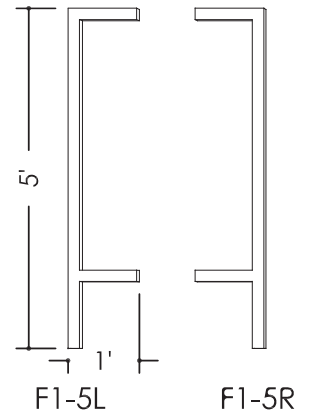

"A" 4'h SET

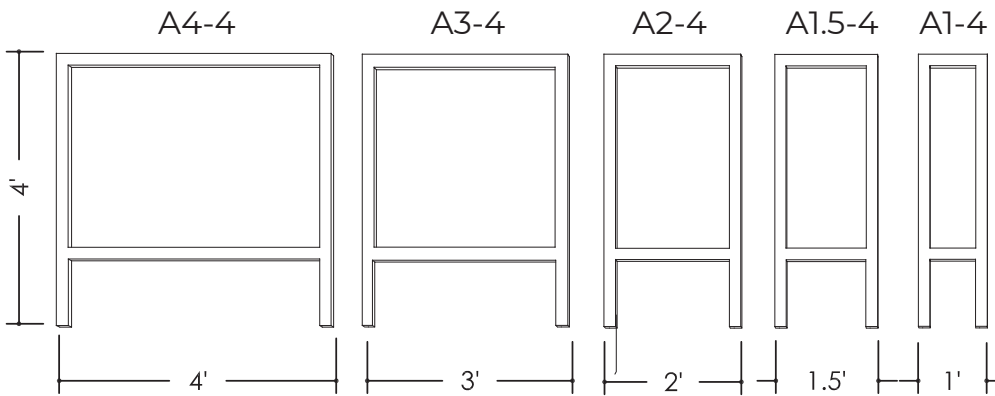

"F1-4" SET

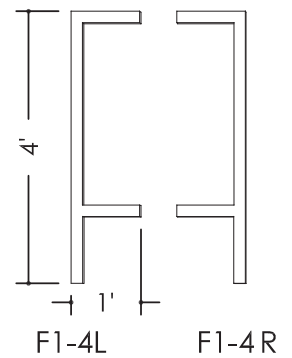

"U" MODULES



UNION EXTENSIONS

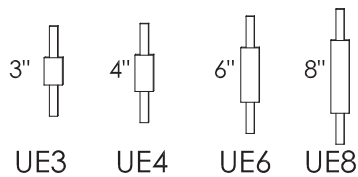

CUSTOM SIZES AVAILABLE

EXTENSIONS

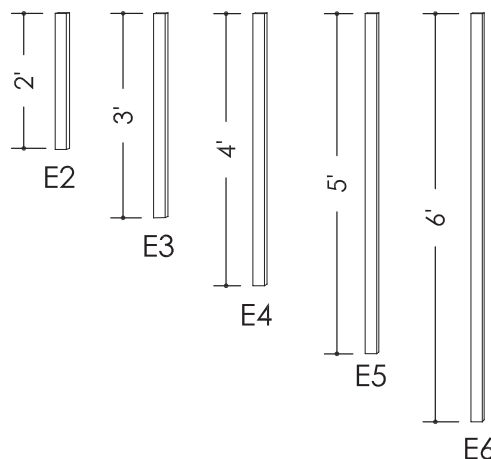

.25R CURVES

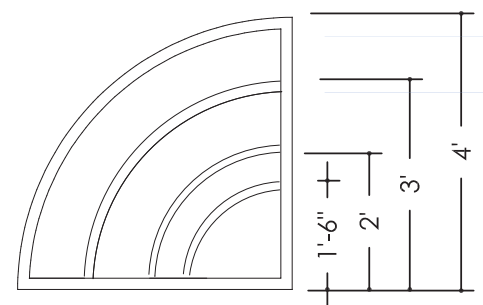

AV-Drop STANDARD COMPONENTS

"X" PIECE

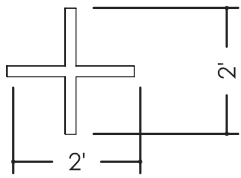

"H" PIECE

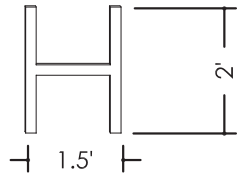

"T" PIECES

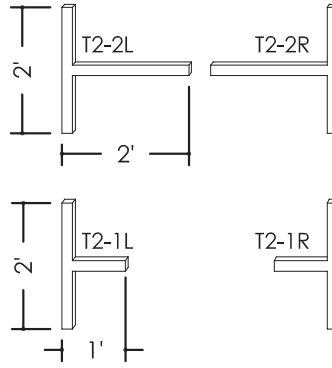

"L" PIECES

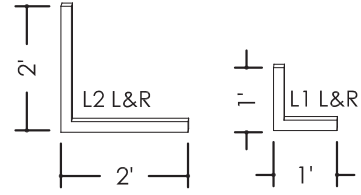

ANGLE SETS

NOTE: CORNER ANGLES ARE 1' x 1.

"T" ANGLES ARE 2' ON LONG SIDE AND 18" ON HORIZONTAL SIDE.

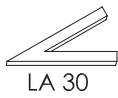
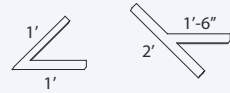

LA 30



LA 45



LA 60



LA 75

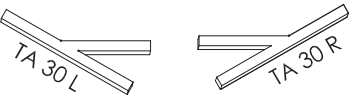

TA 30L

TA 30R

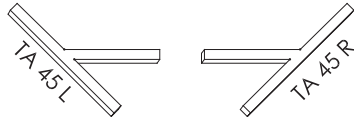

TA 45L

TA 45R



TA 60L

TA 60R

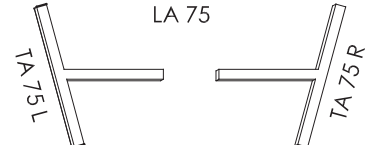

TA 75L

TA 75R



LA 150

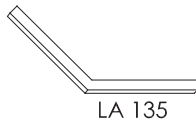

LA 135



LA 120



LA 105

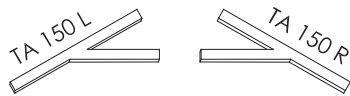

TA 150L

TA 150R

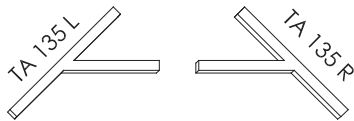

TA 135L

TA 135R

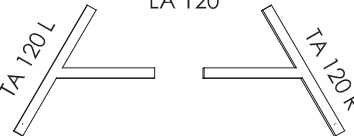

TA 120L

TA 120R

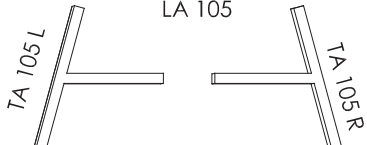

TA 105L

TA 105R

CLAMPS and CONNECTORS

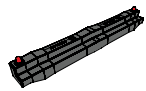

UP

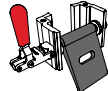

STN-CLP

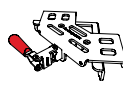

DC-CLP



2H-CLP

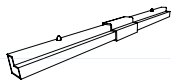

UE PIECE

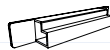

ABE

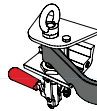

RG-CLAMP

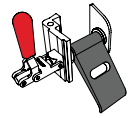

HALF MOON

BRACKETS for SCREENS



BFS

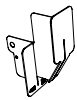

BFS_1.5"

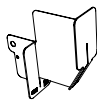

BFS_3.1"

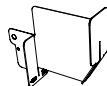

BFS_4.7"

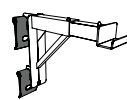

BFS_8-12"

BASE for WEIGHT



SAND BAG
double saddle

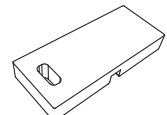

25lb
RUBBER
WEIGHT



BFW