



SHOWLED

classic

Controller Manual

version 3.1

CONTENTS

Introduction	4
Safety instructions	5
How to replace the fuses	6
Controller description	7
Wiring the starcloth to the controller	8
Connecting the ShowLED controller	9
Setting up the control network	9
Stand Alone Mode	9
DMX Mode	10
Mixing controllers with different firmware	11
Stand Alone Mode	11
DMX Mode	12
The operator console and the menu structure	13
Flowchart of the menu structure	14
Description of the parameters	16
Graphical presentation of the DMX channel arrangement	19
Tips and tricks	20
FAQ's	20
XLR output detail	20
Troubleshooting	21
Contact Information & Support channels	21
Technical data	22
Declaration of conformity	23

INTRODUCTION

Congratulations on your recent purchase of a ShowLED* Controller with the following features:

- 8 output channels for driving LEDs
- DMX compatible
 - The DMX signal is cleaned up and amplified every time it passes through a controller!
- Two or more controllers can be synchronised
- Chase patterns
 - Stand alone or selected by the DMX signal
 - Selection of hard or soft chase
 - Variable chase speed
 - A number of predefined patterns
- Interactive operator console
 - The parameters of the controller are accessible though the LCD and menu buttons.
e.g. The DMX base address
- The LED outputs are protected against short circuit
- The supply voltage can vary between 90 and 250 Vac
- Uses standard cables
- Energy efficient
- Full range DMX-addressing
- Improved dimmer curve

Notes:

This manual applies to firmware version 1.0 or higher and hardware versions 2.0 and above.

Please consult our website for possible errata and modifications.

*ShowLED is our brand name for LED-products we develop for the entertainment industry.

SAFETY INSTRUCTIONS



WARNING

To avoid electric shock the power cord protective grounding must be connected to ground.

Make sure you understand the function of each connection before you connect it. See that all connections are made correctly before turning on the controller.

Always disconnect the device from the mains supply when connecting the signal leads, the power cord should be connected last.

Do not apply voltage higher than 250 Vac to the device. (See also technical data)

In case of an emergency, you can disconnect power from the device by pulling out the power cord. Keep the power cord easily accessible at all times.

If your application set-up does not allow easy access to the power cord, install a mechanical circuit breaker in the supply-line, going to the device.

The device has 2 fuses placed inside; replace them only with the correct type. See next page how to replace them.

If the controller hangs on a starcloth and is not supported by a floor or a table, you must secure it with a mechanical safety. The connecting cables are NOT mechanical safeties! If you are not familiar with mechanical safeties, feel free to contact us, we can provide you with advice.

Take care with the environmental limits. Do not exceed them. (See technical data)

Keep a minimum distance of 1 meter between you (or the audience) and the LEDs. Do not stare into the LEDs, especially when narrow angle LEDs are used.

This device is designed and tested for driving LEDs; do not use it for other purposes.

Do not expose the controller to water (rain) or direct sunlight.

Do not subject to excessive shock by dropping the unit.

How to replace the fuses

Disconnect the powercord. Unscrew the 4 bolts on the two sides of the device and the 4 top screws of the XLR connectors of the LED outputs (You need a PH1 screwdriver). Remove the top of the device (it is not necessary to disconnect the flat cable you encounter). Locate the fuse holders marked on the PCB as F1 and F2. You can open the fuse holders by turning the caps counter clockwise.

Determine which fuse is blown. (If you are not sure, replace both) Replace the fuse(s) with the right kind (fuse 2.0A slow-blow 5x20 mm). Replace the caps together with the fuses and lock them by turning clockwise.

Put the top of the device back into position and fasten the 4 little bolts on the two sides of the device and the 4 top screws of the XLR connectors of the LED outputs.

Reconnect the powercord and check if the device is working properly.

CONTROLLER DESCRIPTION



WIRING THE STARCLOTH TO THE CONTROLLER

Connecting one cloth to the controller

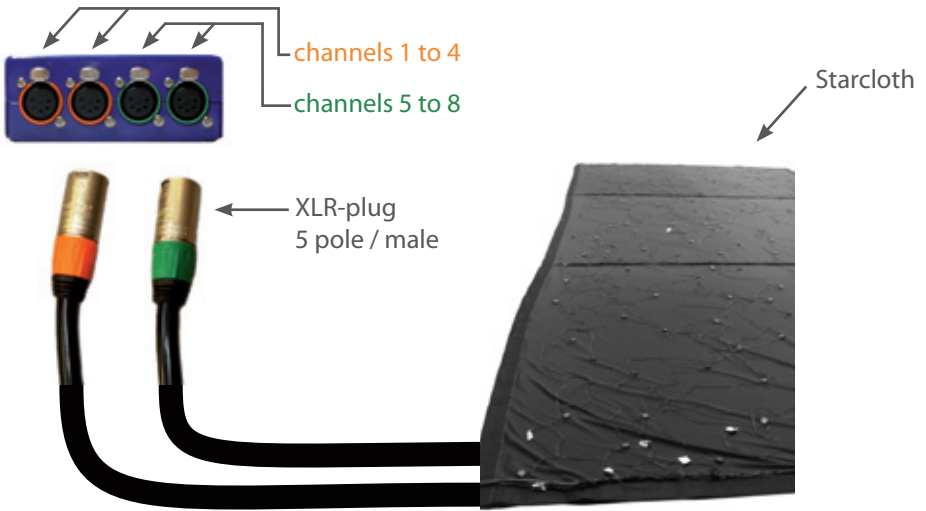

Connecting two small cloths to the controller

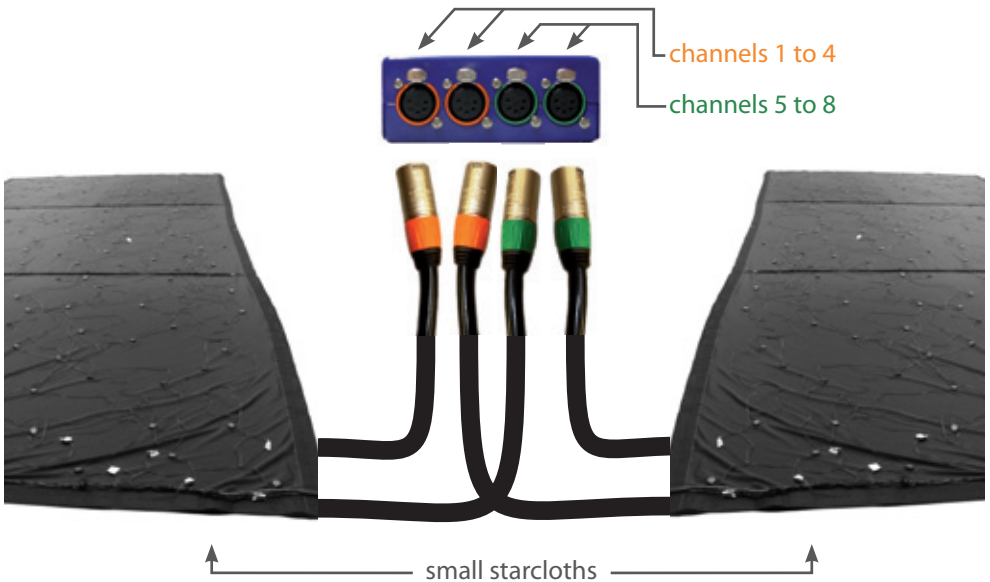

Note:

The connectors with the same colour code are switched in parallel (internally)

CONNECTING THE SHOWLED CONTROLLER

1. Connect your application¹ to the LED output connectors of the controller.
2. Connect the powercord to the MAINS (90-250V) input of the controller.
3. At this point you will need to set the parameters of the controller.
You will learn how to do so from this manual.
4. If you have more than one controller to connect.
See setting up the control network, further in this manual.

SETTING UP THE CONTROL NETWORK

The control network is set up with the use of 5 pole XLR cables. In the following drawings only the control network is drawn. Depending on your application, you will choose a configuration.

Stand Alone Mode (No lightboard present)

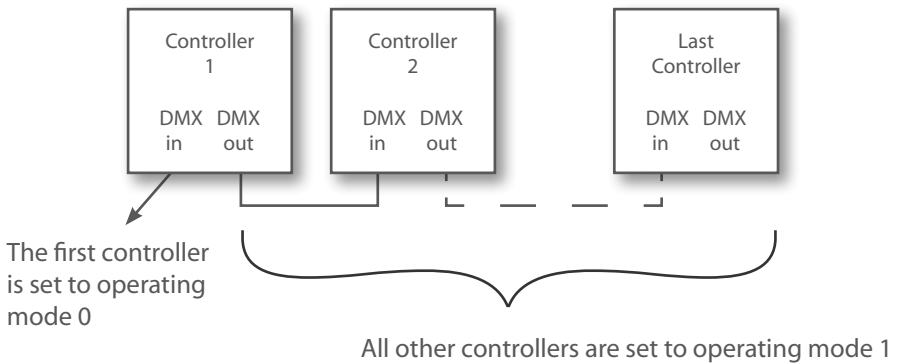

All parameters can be altered on the first controller.

¹ For instance, a starcloth, a logo, ...

SETTING UP THE CONTROL NETWORK

DMX Mode

Configuration 1: Using the built-in patterns (With use of a lightboard)

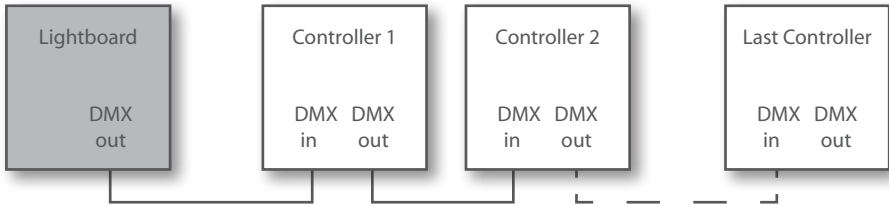

In this configuration controller 1 is set in mode 10; all the others are set in mode 1. This configuration requires minimum 5 DMX channels.

Note: if you want to add another device (moving heads, dimmers,...) to this control network, it can only be put before the first controller!

Configuration 2: Dimming function of each output

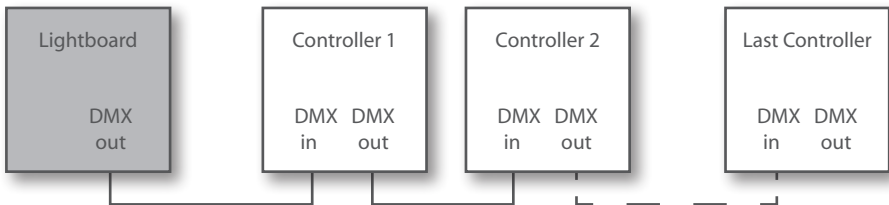

In this configuration all the controllers are set in mode 8. This configuration requires minimum 8 DMX channels.

You can choose if you want to address the controllers all together or separately. By setting all the controllers in this control network on the same DMX base you can address all the controllers together. By setting all the controllers in the control network on a different DMX base (e.g. 1, 9, 17, 25 ...) you can address all the controllers separately.

Note: if you want to address all the controllers separately, you will need 8 DMX channels per controller. (e.g. 4 controllers require 32 channels)

MIXING CONTROLLERS WITH DIFFERENT FIRMWARE

Stand Alone Mode

Master slave operation (No lightboard present)

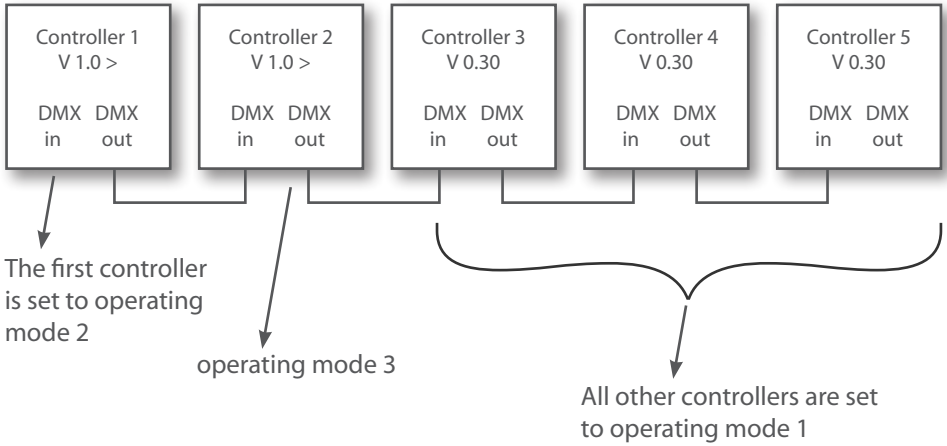

Legend

V 1.0 >: firmware version 1.0 or higher

V 0.30: firmware version 0.30

MIXING CONTROLLERS WITH DIFFERENT FIRMWARE

DMX Mode

Configuration 1: Using the build in patterns (See also configuration 2)

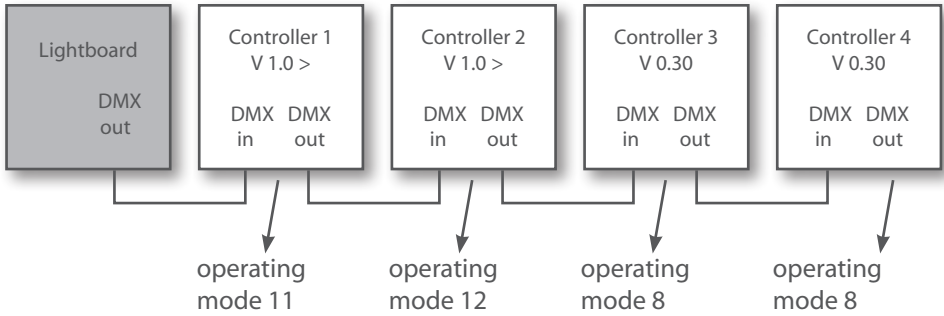

Configuration 2: Dimming function of each output (See also configuration 3)

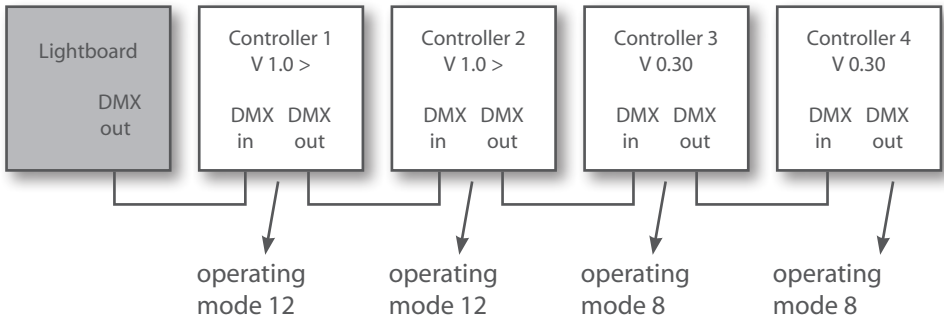

Legend

V 1.0 >: firmware version 1.0 or higher

V 0.30: firmware version 0.30

THE OPERATOR CONSOLE AND THE MENU STRUCTURE

The operator console consists of an LCD and three buttons. This console is the physical interface that lets you access a menu structure. The menu structure lets you modify the parameters of the device.

The first button (PRG) has a double function, depending on where you are in the menu structure; the function can be an Escape or a Confirmation. The UP button lets you navigate through the structure or increment a parameter. The DOWN button lets you navigate through the structure or decrement a parameter.

A flowchart of the menu structure is given on the next page. The structure has three types of submenus, namely actions, set-up parameters and operational parameters.

Actions

- Exit no changes
 - Escape function, the previously saved parameters are restored.
- Return default
 - The parameters are restored to the factory defaults.
- Broadcast parameters
 - Passes the parameters to the other controllers in the DMX-chain.
- Exit and save
 - After altering the parameters and the parameters are satisfying, you must save them
- Firmware Vx.xx
 - Displays the current firmware of the device. It's an aid to help us to give you additional support.

Set-up parameters

- Operating mode
- DMX base

Operational parameters

- Pattern type
- Pattern behaviour
- Chase speed
- Minimum intensity
- Maximum intensity

You need to alter only the set-up parameters when the set-up of your application changes. You will find an explanation of the parameters in section "description of the parameters".

Modify values with the UP and DN buttons

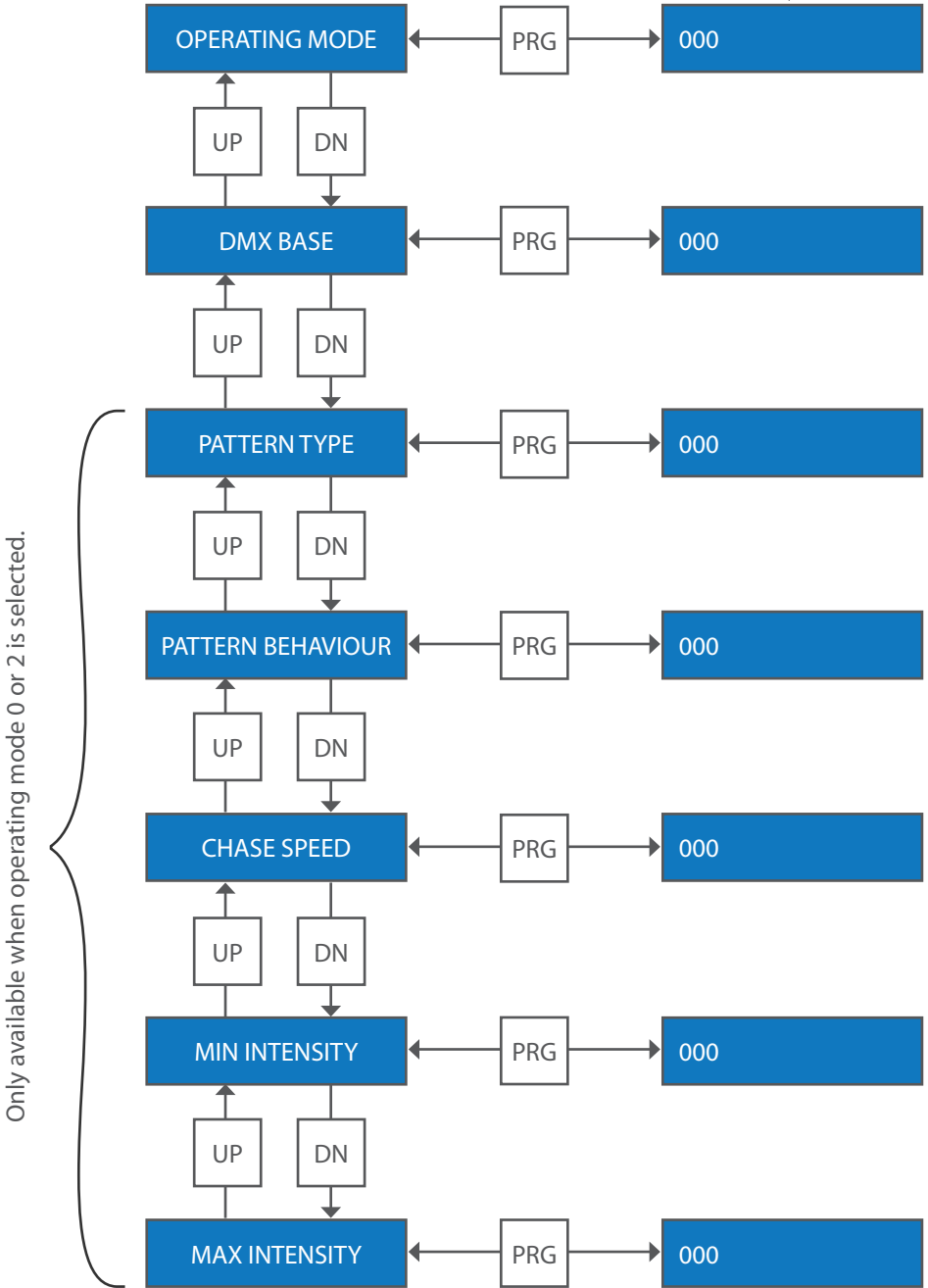

DESCRIPTION OF THE PARAMETERS

Operating mode

This is the first parameter you need to set before entering the other ones. Depending on the configuration of your application you must choose a certain operating mode.

See also section “Setting up the control network” for more clarity.

Mode	DMX channel requirements	Description	Access to the operational parameters	Dimmer curve
0	*	Stand-alone operation (Master)	On the controller (menus)	Improved
1	*	Stand-alone operation (Slave, listens to other controller in mode 0)	*	Improved
2	*	Stand-alone operation (Master)	On the controller (menus)	Standard
3	*	Stand-alone operation (Slave, listens to other controller in mode 0)	*	Standard
4	*	reserved	*	*
5	*	reserved	*	*
6	*	reserved	*	*
7	*	reserved	*	*
8	8	Dimming function of each output	*	Improved
9	5	Pattern type, Pattern behaviour, Chase speed, Min. Intensity, Max. Intensity	By the DMX signal	Improved
10	5	Pattern type, Pattern behaviour, Chase speed, Min. Intensity, Max. Intensity (solves synchronisation problems)	By the DMX signal	Improved
11	5	Pattern type, Pattern behaviour, Chase speed, Min. Intensity, Max. Intensity (solves synchronisation problems)	By the DMX signal	Standard
12	8	Dimming function of each output	*	Standard
13	*	reserved	*	*
14	*	reserved	*	*
15	*	reserved	*	*

*: Doesn't apply

Notes

Mode 0: The controller will act as a lightboard for the other controllers.

Mode 9, 10 and 11: You can address remotely the operational parameters by the DMX-signal. It will save you time; you don't have to program your own sequences.

DMX base

Use this parameter to set the DMX base address of the ShowLED controller. The DMX base address¹ can be set between 1 and 504.

The following built-in patterns are only available if operating mode 0, 2, 9, 10 or 11 is selected!!! If operating mode 0 or 2 is selected, they are available on the operator console. If operating mode 9, 10 or 11 is selected, they are available through the DMX signal.

Pattern Type

(Channel offset 0)

DMX value	Function	Description
0.. 7	All Channels OFF	*
8.. 31	Chase Pattern 1	Random, min. 3 channel on
32.. 55	Chase Pattern 2	Special
56.. 79	Chase Pattern 3	Sequence with 4 channels on
80.. 103	Chase Pattern 4	Sequence with 5 channels on
104.. 127	Chase Pattern 5	Sequence with 6 channels on
128.. 151	Chase Pattern 6	Running light 7 channels on
152.. 175	Chase Pattern 7	Running light 6 channels on
176.. 199	Chase Pattern 8	Running light 5 channels on
200.. 223	Chase Pattern 9	Running light 4 channels on
224.. 247	Chase Pattern 10	STROBE
248.. 255	All Channels ON	*

*: Forced operation, all other parameters have no influence.

¹ The DMX base address is also known as the "DMX start address"

Pattern Behaviour

(Channel offset 1)

DMX value	Description
0..63	Soft chase
64..127	Hard chase
128..191	Soft chase, inverted pattern
192..255	Hard chase, inverted pattern

Chase Speed

(Channel offset 2)

DMX value	Description
0	Minimum speed
..	
255	Maximum speed

Minimum Intensity

(Channel offset 3)

Limiter function sets the minimum intensity level. When set to a value higher than zero, the LEDs will not dim completely.

Maximum Intensity

(Channel offset 4)

Limiter function sets the maximum intensity level. When set to a value lower than 255, the LEDs will not light up at full capacity.

Note: the maximum intensity has a higher priority than the minimum intensity!

GRAPHICAL PRESENTATION OF THE DMX CHANNEL ARRANGEMENT

This is only valid if **operating mode 9, 10 or 11** is selected. This presentation can be of help when you are using a low-cost DMX lightboard.

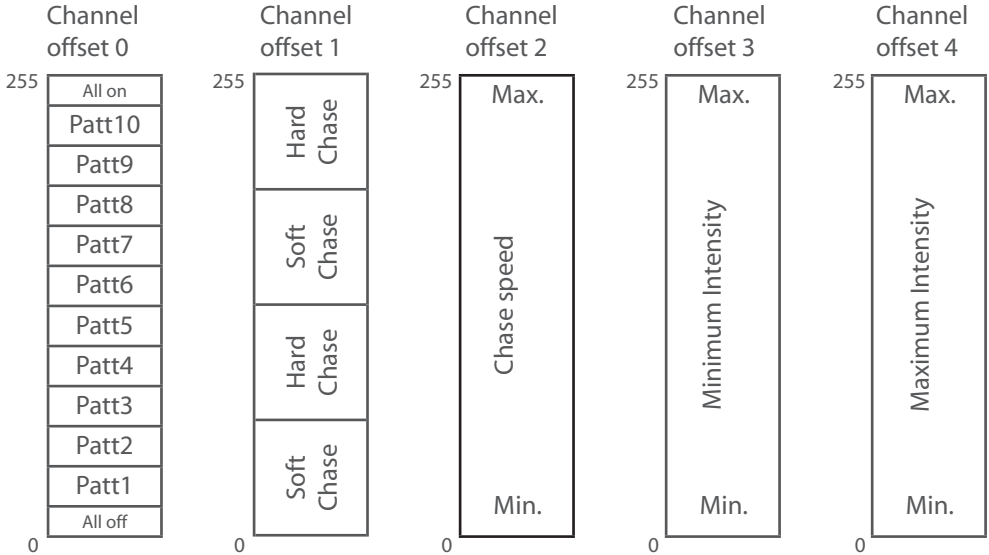

This is only valid if **pattern 2** is selected.

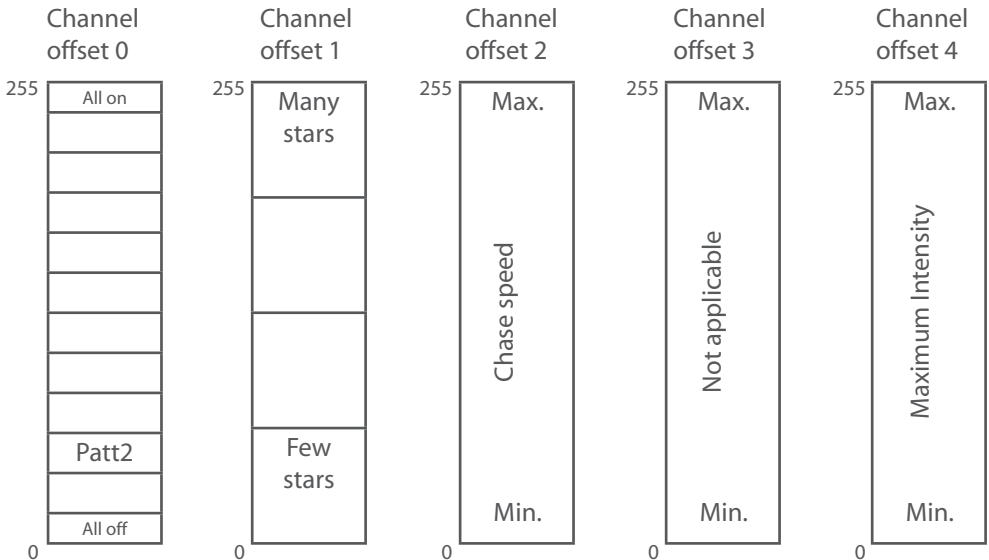

TIPS AND TRICKS

If you have altered one or more parameters, make sure to leave the menu with the action "exit and save". Otherwise your settings will be lost when the controller is turned off.

A quick way to make the LEDs light up is to set the controller in default mode. Push the PRG-button, the DOWN-button and again the PRG-button.

FAQ's

1. How can I read the firmware version?

Press the PRG button once. Press 4 times the Down button. Now you're able to read the firmware version.

2. Where can I find which hardware version my controller has got?

At the back of the device you'll find a barcode (serial number). The code is built as follows, for example: *025608D02000092*

↑
These three digits represent the hardware version.
020 reads as version 2.0

3. What is the maximum length of the cable between the controller and the cloth?

You can determine the maximum length of the cable by using the following table.

		Number of LEDs in the cloth			
		96	128	192	256
Wire Size (mm ²)	0,5	27m	20m	13m	10m
	0,75	40m	30m	20m	15m
	1,0	53m	40m	27m	20m

XLR OUTPUT DETAILS

XLR port 1 and 2 (orange)

- Pin 1 - channel 1
- Pin 2 - channel 2
- Pin 3 - channel 3
- Pin 4 - channel 4
- Pin 5 - common anode

XLR port 3 and 4 (green)

- Pin 1 - channel 5
- Pin 2 - channel 6
- Pin 3 - channel 7
- Pin 4 - channel 8
- Pin 5 - common anode

TROUBLESHOOTING

The controller won't turn on!

Make sure you have tension on the power outlet. (A multimeter can be helpful in checking this!) If you are sure that you have tension from the power outlet, connect the powercord to the device.

If the LEDs are not lit and there is no text on the display and the display backlight is not lit, the fuse(s) are probably blown. If you need to replace the fuses make sure to follow the procedure explained in the section "Safety instructions"

The LEDs don't light up!

If the display works but the LEDs don't light up, set the controller in default mode. Push the PRG-button, the DOWN-button and again the PRG-button.

If the LEDs are still not lit the problem probably lies in the wiring.

TECHNICAL DATA Specs are listed for both controllers, the LC025608DR difference is between brackets ().

Electrical

Input

Input voltage range	90 - 250	V ac
Line frequency	47 - 63	Hz
Input current at 100/230 V AC ¹	0.8 - 0.45 (0.6 - 0.4)	A
Inrush current ²	15	A
Input power	50 (33)	W
Fuses	2 x T2.0A slow-blow ³	

Output⁴

Output voltage	5	V dc
Output current ⁵	8 (5)	A dc
Output power	40 (25)	W
Fuses ⁶	Polymeric (PPTC)	

Environmental

Operating

Ambient temperature	5 - 45	°C
Relative humidity ⁷	< 80	%

Storage⁸

Ambient temperature	5 - 35	°C
Relative humidity	< 60	%

Mechanical

Dimensions	190 x 112 x 43	mm
Weight	1186	g

¹ at nominal load

² start up current, only lasts for 2 milliseconds

³ placed inside the device

⁴ when the outputs are set to maximum and have a nominal load

⁵ the sum of the 8 outputs

⁶ every led output is short circuit protected by an automatically reset table fuse

⁷ no condensing

⁸ the stricter storage parameters ensure a long life of the LCD

DECLARATION OF CONFORMITY (3rd edition)

We, ShowLED FZC

P.O. Box : 120888 - Warehouse Q4-006 - Sharjah Airport Free Zone - Sharjah - UAE

Declare that the product

ShowLED Classic System, containing a subset of the following components
Controller type LC025608DR, Controller type LC051208DR,
Led string type BW-12LED, Led string type BW-16LED

is in conformity with the essential requirements of the following directives and standards:

Low Voltage Directive (73/23/EEC)

EN 60950 (2nd Ed) Standard for safety of information technology equipment
Including amendments A1, A2, A3, A4 and A11.

EMC Directive (89/336/EEC) and 92/31/EEC

- EN 55103-1 Electromagnetic compatibility for audio, video, audio-visual and entertainment lighting control apparatus for professional use.
Part 1: Emission
- EN 55103-2 Electromagnetic compatibility for audio, video, audio-visual and entertainment lighting control apparatus for professional use.
Part 2: Immunity
- EN 55022 Standards of radio disturbance of information technology equipment.
- EN 55024 Standards of immunity characteristics of information technology equipment.

Sharjah, United Arab Emirates

Kenny Janssens, Managing Director

01/9/2011

(Date of issue)

(Signature of authorised person)

SHOWLED

LED starcloths for:

theatres
TV studios
concerts
night clubs
exhibitions
corporate events
movie theatres
cruise ships